

Applanation Tonometer YZ30 Application Instruction

I. Abstract

Tonometer is an important instrument to measure the intraocular pressure. Following the principle of Goldmann applanation tonometer, our factory produced the applanation tonometer model YZ30. Press flat a certain area (3.06mm diameter) of patient's cornea with different pressure through pressure-measuring probe inlaid with a prism. Under slit lamp microscope, and with the help of illumination of fluorescence and blue rays, two green semi-circles whose inner parts connect each other can be seen. Thus, numerical value of intraocular pressure (IOP) can be got from the reading turn drum.

As the cornea area pressed flat by the tonometer is very small, change of IOP caused by outer force is also very small. The eye pressure we get is nearer to the true value of IOP as compared with Schiötz tonometer, with the mean error no more than $\pm 0.066\text{Kpa}$. It is one of the commonly-used tonometer.

II. Main Specifications

Measuring range: 0~10.6Kpa

Movement of light circle: $1.53 \times 2 = 3.06\text{mm}$

Diameter of probe: 7mm

Moving range of probe: 3mm

With slit lamps: serials of Crane and others with suspension arm interface

Wight: 300g

Size: 190×80×80 mm

III. Strong points

1. Measurement under slit lamp microscope can have two effects: inspect the eye and measure the intraocular pressure.
2. Numerical value is precise. The tonometer's own error is only $\pm 0.066\text{Kpa}$.
3. Get numerical value of IOP directly. No need to look up tables or do matrixing. And $P_t = P'$, i.e. $t_g P_t - t_g P_0 = 0.56k$, normal $k = 0.0215$, then: $P_t : P_0 = 1.0281$. So P_t adds 2.8% comparing with P_0 .
4. The hardness of sclera does not affects the numerical value. Change of the volume of eyeball is only 0.56mm^3 .
5. Combine with the measurement method of Schiötz tonometer, counting the hardness of sclera can be done.
6. The measuring-pressure can be to calibrated, guarantee the stability over a long period of time and reliability of measurement.

IV. Design principle

The design principle of Goldmann applanation follows the theory of Imbert-Fick.

$P_t = W/A$, if $W = \text{pressure of 1 gram (1g = 1cm}^3\text{H}_2\text{O} = 100\text{mm}^3\text{H}_2\text{O} = 1000/13.6\text{mm}^3\text{Hg})$, in this formula, 13.6 is gravity of Hg). Area of applanated circle: $A = \pi R^2 = 3.1416 \times (3.06/2)^2 = 7.354\text{mm}^2$, $P_t = 100\text{mm}^3\text{H}_2\text{O}/7.354\text{mm}^2 = 135.98 \text{ mmH}_2\text{O} = 135.98/13.6\text{mmHg} = 10\text{mmHg}$. So if the tonometer adds one grams of pressure, the measured IOP is 10mmHg. In another word, loading gram on the reading turn drum $\times 10 = \text{IOP}$ expressed as mmHg.

Measurement of applanated area is done directly on the cornea through pressure-measuring bi-prism and observed under the microscope.

V. Preparation before measuring

A. Preparation of patients

1. Clean the front part of probe with solitude of mercury benzene borate of 1:32000 or sterilized fluid that will not damage the probe. Then wipe with sterilized cotton pick. And insert it into the metal covering on the top of lever of tonometer.
2. Drop 0.2% novesin (or other available surface anesthetic for ophthalmic) into the eye to do surface anesthesia. Once time every 1-2minutes, twice to three times together. Do anesthesia to both eyes to avoid blinking.
3. Fluorescence dying the eye
4. Put the fluorescence paper inside the fornix conjunctival flap under the examined eye. This lasts several seconds.
5. A glass soaks with 0.5% fluorescence to the conjuction.

B. Preparation of tonometer and slit lamp microscope

1. Assemble the tonometer onto the slit lamp microscope. Doctor can watch through the eye-piece on the leftside.
2. The intersection angle between the illumination of slit lamp and microscope should be $40\sim 60^\circ$ angle. This helps to brighten the head of probe. The slit diaphragm is opened to 8mm round light spot. A piece of cobalt blue filter is inserted into the illumination light way so that the yellow-green fluorescence can be seen clearly. With $10\times$ microscope, and reading turn drum at 1gram of loading.

C. Preparation of measurement

1. Adjust the direction of probe according to the patient's cornea. If the cornea is spherical, the easier way is to measure horizontally (i.e. point '0' on the head aligns to white mark line of cover ring). If patient's

cornea astigmatism exceeds 3D, and the applanated area is not round but oval, turn the horizontal axis of up-and-down prisms to the meridian of 43 degree of intersected long axis of oval, so that the applanated area is still 7.354mm^2 . For example, postulate the cornea astigmatism is 120 degree, curve radius of meridian is 6.5mm (=58D); curve radius of 30 degree meridian is 9.5mm (40D), meridian direction of lowest diopter is 30 degree, long axis of pressed oval is also 30 degree (refer to FIG.1), so align the mark 30 degree of probe to the red mark of 43 degree on the prism cover. The cornea applanated surface of hype-astigmatism is oval. Only at the direction of 43 degree axis, the diameter of oval is the same with that of circle of same square.

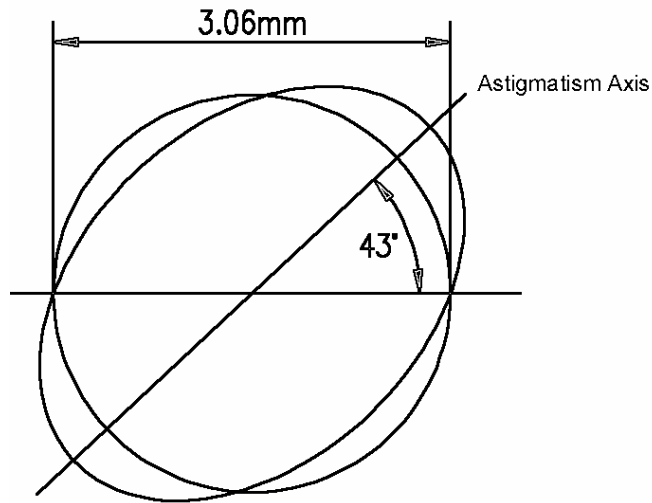

Fig.1

2. Patient's head is fixed on the forehead rest and chin rest of slit lamp.
3. Require the patient to open eye widely to look forward. Or the fixation lamp is used to control watching direction of patient's eye. If necessary, doctor can widen the patient's eyelid with hand, but not to press the eyeball.
4. Before measurement, require the patient to blink his eyes some times to make cornea be evenly moist with fluorescence and tear.

VI. Measurement

1. move slit lamp (together with tonometer) forwards slowly to make the probe touch with the center of cornea tip.
2. Watch through leftside eyepiece of microscope with left eye, two small semi-circles which do not connect can be seen (Fig. 2). Turn reading turn drum and increase pressure on the cornea (originally at the scale of '1') till two semi-circles connect to each other(refer to Fig. 3) (width of

circle is about one tenth of diameter of applanated area, i.e. 0.3mm). Read the numerical value of pressure and turn to '0' again, semi-circles depart again. Measure for three times like this way, if the reading value is almost the same, the measurement is right.

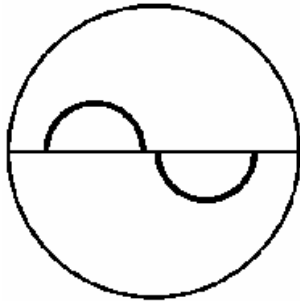

Fig. 2

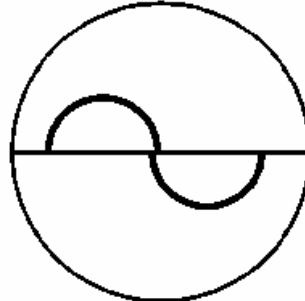

Fig. 3

3. Take out tonometer quickly through controlling level. Times the reading with 10, i.e. mmHg of practical intraocular pressure.

VII. Notes

1. Eyelash is not allowed to press on the cornea by the prism while in pressing.
2. Do trial measurement for the patients who do not cooperate. No record till the real test when patients cooperate.
3. If the probe touches cornea too long, cornea endothelium will be dyed to affect the precise measurement. Times of measurement will make the numerical value be bit lower.
4. When cornea is getting to thick or unsmoothly caused by cornea lesion, this tonometer is not allowed to measure as the result is not correct.
5. While the tonometer is not used, turn reading turn drum to the place '0' to assure precision of tonometer and lengthen the service life.
6. Reasons of error and methods of correction when measuring
 - A. Semi-circles formed by fluorescence belt have equal area and proper position. Need to press flat the cornea further.
 - B. Fluorescence belt is too wide. It is because the pressure-measuring head is not dry after cleaning or the eyelid touches the head. In this case, the measured intraocular pressure is higher than practical one. Pull backwards the slit lamp, dry the head. Then measure again(Fig. 4).
 - C. Fluorescence belt is too narrow. It is because tears has been dry. So the measured intraocular pressure is lower than the practical one. Let patient blink his eye for some times. Then measure again(Fig. 5).

- D. As slit lamp is too close to patient's eye, the pressed area is too large. Pull back slit lamp till a proper small area and normal beating are got (Fig. 6).
- E. Location of fluorescence ring is too low. Enhance slit lamp(Fig. 7).
- F. Fluorescence ring close to leftside. Move slit lamp leftside(Fig. 8).
- G. Location of fluorescence ring is close to upper left. Move slit lamp leftwards. Adjust height to pull down(Fig. 9).
- H. Fluorescence ring is close to rightside. Move slit lamp rightwards (Fig.10).

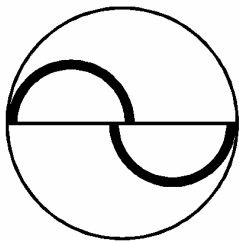

Fig. 4

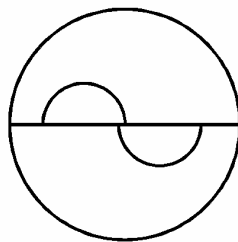

Fig. 5

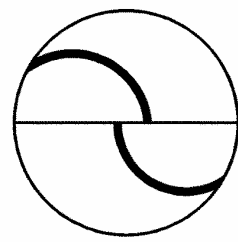

Fig. 6

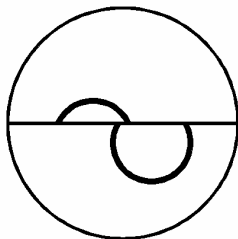

Fig. 7

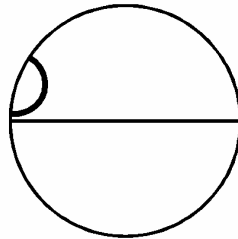

Fig. 8

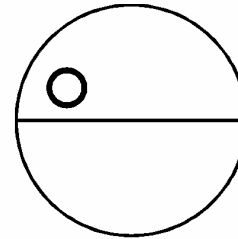

Fig. 9

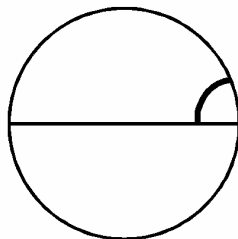

Fig. 10

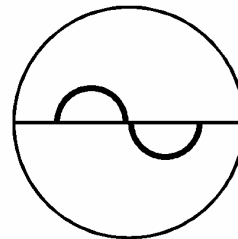

Fig.11

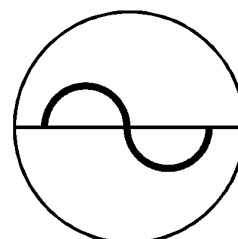

Fig. 12

- I. If fluorescence rings connect along the outside border, pressure should be increased(Fig. 11).
- J. If one fluorescence ring of outside border connects with another's inside border, pressure needs to increase till two inside border touch each other(Fig. 12).

VIII. Calibration of instrument

The instrument should be calibrated every a certain period. The methods are as follows:

1. Calibration of point '0'. Placed the main body of tonometer (removed the suspension arm part) in horizontal way (show as Fig. 13). Probe is put inside the cover ring. Turn reading turn drum to position of '0'. Check the balance of pressing arm of tonometer.

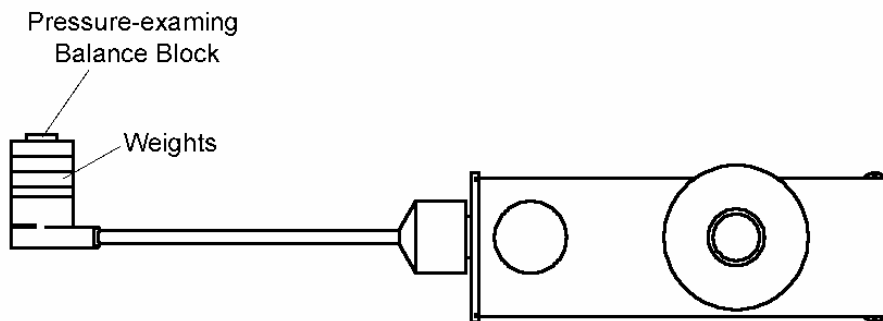

Fig. 13

2. Calibration of '2,4,6,8' gram. If loading a pressure-examing balance block, turn reading turn drum to position of '2'; put a weight of 2 gram, turn reading turn drum to position of '4'; put two weights of 2 gram, turn reading turn drum to position of '6'; put three weights of 2 gram, turn reading turn drum to position of '8'. Under these four conditions, if the pressing arm of tonometer all balance, mechanized parts of tonometer are normal.
3. If the tonometer lose its balance at position of '2,4,6,8' gram, it could be re-balanced by gently adjust the adjustment-bar with screw-driver (refer to Fig. 14). It's measuring-spring should be changed by return to our factory products repair department when it is unable to reach balance through adjustment.

IX. Accessories

Three probes made of organic glass. One set of calibration weight.

X. Assemble

1. This type tonometer suit for slit lamp microscope with suspension arm interface.
2. Take out the tonometer from packaging, mounted by telescoped sleeve of suspension with the pivot of the joint on the microscope, pull down to proper position.

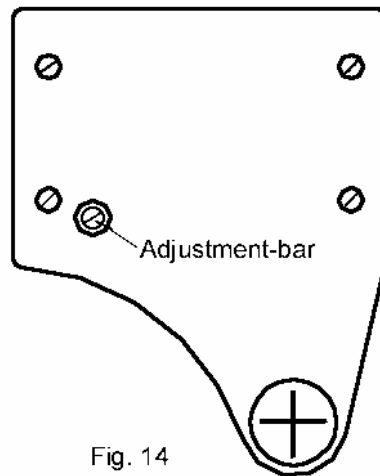

Fig. 14